

San Joaquin Public Health Laboratory

Specimen Collection Guide

Version 2024, Effective Date 1.31.24

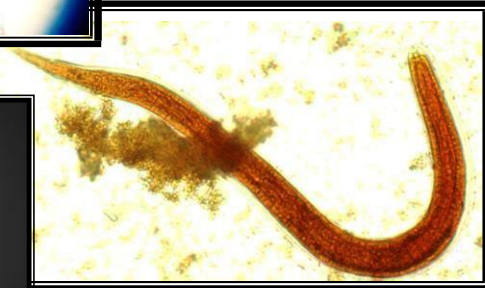
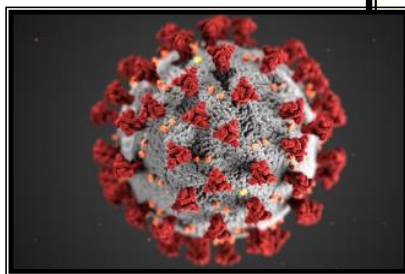
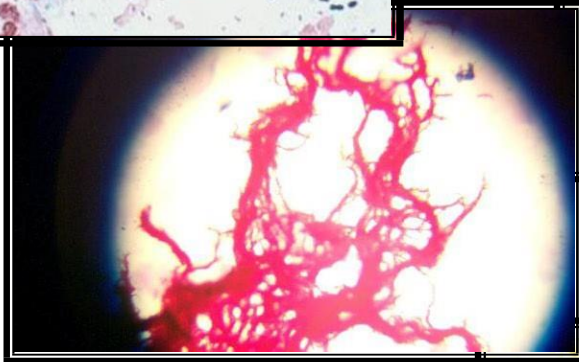
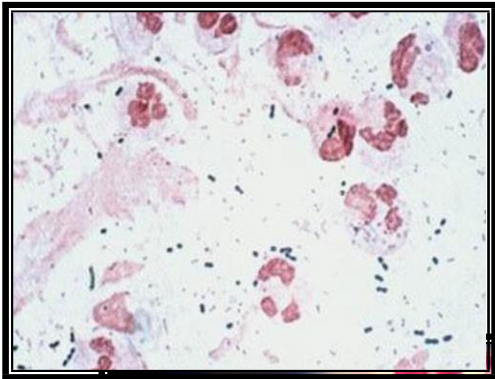

Table of Contents

	Page
General Information:	
Phone Numbers	3
Laboratory Accreditations	3
Laboratory Requisition Example	4
Specimen Collection and Shipping Guidelines	5-8
Laboratory Test Alphabetical	9
Collection Guides:	
Bacteriology	10-15
Parasitology	16
Mycology	17
Serology	18-19
Virology	20-23
Information on Viral Disease and Agents:	
AIDS (HIV)	24
Arbovirus Tests	24
Cerebrospinal Fluid Antibodies	24
Chlamydia Infections	24
Colorado Tick Fever	25
Coxsackievirus and Echovirus Infections	25
Epstein-Barr (EBV) Tests	25
Gastroenteritis, Viral Diarrhea	26
Hepatitis C	26
Influenza	26
Mpox	26
Rhinovirus	26
Rickettsial Serologic Tests	26
SARS-CoV-2	27
Smallpox virus	27
Viral Hemorrhagic Fevers	27
Specimen Container Guide:	
Sterile Specimen Cup	28
Blood Transport Tube with SPS	29
Hologic Aptima Endocervical and Male Urethral	29
Swab Collection and Urine Collection Kit – Chlamydia/GC	29-30
M4 RT Transport Media	31
MCC Total-Fix	32
Cary Blair Transport media	33
Pinworm Paddle	34
Dacron or Rayon or Flocked NP Swab/Sterile Tube (for aspirate only)	34
QuantiFERON-TB Gold Plus	35
BactiSwab Stuarts Media	36
Vacutainer Serum Separator	37
Measles Collection	38
Mumps Collection	39
Mpox Collection	40
COVID (SARS CoV-2) Collection	41-42
References	43

San Joaquin County Specimen Collection Guide

GENERAL INFORMATION

Laboratory Phone Numbers

Days of Operation:	Monday-Friday
Hours of Operation	8 am – 5 pm (Closed 12-1 lunch)
Main laboratory:	(209) 468-3460
Fax Number:	(209) 468-0639
After Hrs Emergency No.	(209) 468-6000 (24/7 Phone #)

Contact Email phslabmgrs@sjcphs.org

Laboratory Accreditations:

CLIA:	05D0643989
California Dept. Public Health	1249
ELAP	1892
API	57887
CAP	2403001-01
WSLH	4204

Other Useful Numbers

Alpine County Health Department.....	Phone:	530-694-2235
	Fax:	530-694-2252
Amador County Health Department.....	Phone:	209-223-6407
	Fax:	209-223-1562
Calaveras County Health Department.....	Phone:	209-754-6460
	Fax:	209-754-1709
Mariposa County Health Department.....	Phone:	209-966-3689
	Fax:	209-966-4929
Mono County Health Department.....	Phone:	760-924-1830
	Fax:	760-924-1831
Stanislaus County Health Department.....	Phone:	209-558-7000
	Fax:	209-558-7531
San Joaquin County Health Department.....	Phone:	209-468-3411
	Fax:	209-468-3823
Tuolumne County Health Department.....	Phone:	209-533-7403
	Fax:	209-533-7406

San Joaquin County Specimen Collection Guide

Laboratory Requisition Form Example

Refer to http://www.sjcphs.org/diseases/public_health_Laboratory.aspx for current version



SAN JOAQUIN COUNTY
PUBLIC HEALTH LABORATORY
1801 E. HAZELTON AVE.
STOCKTON, CA 95205
Hameet Kaur, Ph.D., HCLD (ABB), Lab Director
Phone: 209-488-3460
Fax: 209-488-0639
CLIA # 05D0643889

LABORATORY USE ONLY	
LAB NUMBER _____	DATE / TIME RECEIVED _____

Revised 2.9.23 HK/ SS

<p>SUBMITTER</p> <p>Agency/County Name: _____</p> <p>Site Name: _____</p> <p>Street Address: _____</p> <p>City, State, Zip _____</p> <p>Physician /NPI#: _____</p> <p>Phone: _____, Fax: _____</p>	<p>Patient Name: _____</p> <p style="text-align: center;">Last Name First Name Middle Initial</p> <p>Street Address: _____</p> <p>City _____ State _____ Zip _____</p> <p>County: _____</p> <p>Phone: _____</p> <p>Medical Record #: _____</p> <p>Accession # _____</p> <p>Birth date: _____ GENDER: M <input type="checkbox"/> F <input type="checkbox"/> Trans M <input type="checkbox"/> Trans F <input type="checkbox"/></p> <p>Pregnancy Status: <input type="checkbox"/> Pregnant <input type="checkbox"/> Not Pregnant <input type="checkbox"/> Unknown <input type="checkbox"/> N/A</p> <p>Diagnosis Code/ICD 10 Code: _____</p> <p>IF PATIENT IS DECEASED, Specify Date of Death: _____</p>
---	--

Billing Information-Check box for billing source (REQUIRED) Submit copy of insurance card and verification

Policy # _____

Submitter
 Medi-Cal
 Medicare
 FFACT
 Health Plan of San Joaquin
 Health Net
 other insurance _____

No charge (Title 17 or CD/Health Officer Approval) Contract

Specimen Information

DATE SPECIMEN TAKEN: _____ **TIME SPECIMEN TAKEN:** _____ **SPECIMEN SITE:** _____

SPECIMEN SOURCE: (check one from below)

Blood CSF Nasal pharyngeal Rectal Sputum Urethra Vaginal Bronchial alveolar lavage
 Cervix Feces Lesion Serum Throat Urine Plasma other _____

Laboratory Tests Requested (*denotes tests requiring CD/Health Officer Approval prior to submission)

<p>BACTERIOLOGY</p> <p><input type="checkbox"/> Enteric culture (stool)</p> <p><input type="checkbox"/> Enteric culture for ID (isolate)</p> <p><input type="checkbox"/> Non-enteric culture for ID</p> <p><input type="checkbox"/> Food testing*</p> <p><input type="checkbox"/> Bordetella pertussis culture/PCR</p> <p><input type="checkbox"/> Shiga toxin PCR</p> <p><input type="checkbox"/> Streptococcus culture</p> <p>MYCOBACTERIOLOGY</p> <p><input type="checkbox"/> Acid Fast Culture</p> <p><input type="checkbox"/> Acid Fast Smear</p> <p><input type="checkbox"/> Drug Susceptibility (Mtb only)</p> <p><input type="checkbox"/> Mycobacteria I.D.</p> <p><input type="checkbox"/> Mycobacterial DNA Probe</p> <p><input type="checkbox"/> Mycobacterium tuberculosis NAAT (GeneXpert)</p> <p><input type="checkbox"/> QuantiFERON TB Gold Plus</p>	<p>STD SCREENING</p> <p><input type="checkbox"/> Gonorrhea culture</p> <p><input type="checkbox"/> Gonorrhea NAAT</p> <p><input type="checkbox"/> Chlamydia NAAT</p> <p><input type="checkbox"/> Trichomonas NAAT</p> <p>SYPHILIS</p> <p><input type="checkbox"/> RPR</p> <p><input type="checkbox"/> TP-PA</p> <p><input type="checkbox"/> VDRL (Spinal Fluid only)</p> <p>HIV</p> <p><input type="checkbox"/> HIV Ab/Ag Screen</p> <p><input type="checkbox"/> HIV Confirmation</p> <p><input type="checkbox"/> HIV Qualitative NAAT</p> <p><input type="checkbox"/> HIV Quantitative Viral Load</p> <p>HEPATITIS</p> <p><input type="checkbox"/> Hepatitis C Qualitative NAAT</p> <p><input type="checkbox"/> Hepatitis C Quantitative Viral Load</p>	<p>VIROLOGY</p> <p><input type="checkbox"/> Norovirus NAAT*</p> <p><input type="checkbox"/> Enterovirus NAAT*</p> <p><input type="checkbox"/> Flavivirus NAAT*</p> <p><input type="checkbox"/> Respiratory NAAT Panel</p> <p><input type="checkbox"/> Gastrointestinal NAAT Panel</p> <p><input type="checkbox"/> Influenza diagnostic NAAT</p> <p><input type="checkbox"/> Influenza subtyping NAAT</p> <p><input type="checkbox"/> Herpes 1 & 2 / VZV NAAT</p> <p><input type="checkbox"/> Measles NAAT*</p> <p><input type="checkbox"/> Mumps NAAT*</p> <p><input type="checkbox"/> Influenza SARS-CoV-2 (Flu SC2) Multiplex</p> <p><input type="checkbox"/> SARS-CoV-2 NAAT</p> <p><input type="checkbox"/> SARS-CoV-2 Whole Genome sequencing (WGS)*</p> <p>VIRAL SEROLOGY</p> <p><input type="checkbox"/> Rubeola Antibody</p> <p><input type="checkbox"/> WNV Antibody</p> <p><input type="checkbox"/> SARS -COVID Total Antibody*</p>	<p>MYCOLOGY</p> <p><input type="checkbox"/> Fungus Culture for ID</p> <p>PARASITOLOGY</p> <p><input type="checkbox"/> Blood Smear</p> <p><input type="checkbox"/> Helminth Identification</p> <p><input type="checkbox"/> Arthropod Identification</p> <p>Title 17 Submission/Surveillance</p> <p><input type="checkbox"/> Title 17 submission</p> <p><input type="checkbox"/> Surveillance</p> <p><input type="checkbox"/> Other</p>
--	--	---	--

*Testing will require approval of the San Joaquin/ or other County Public Health partners prior to submittal

Specimen Collection and Shipping Guidelines

Purpose: The document provides general specimen collection guidelines for healthcare providers and public health staff. The specimens listed in this document are those that may need to be collected to detect the etiologic agent in question or during a disease outbreak. When a specific pathogen is known or very strongly suspected, specimen collection should be tailored to the pathogen.

San Joaquin County Public Health Laboratory (SJCPHL) does not have facilities for specimen collection. Contact SJCPHL for assistance with any collection guidance or questions. All specimens for examination should be submitted to the Public Health Laboratory by approved methods.

The accuracy of any test procedure is dependent on the quality of the specimen. Quality of the specimen is dependent on how and when it was collected, specimen preservation and transportation to the laboratory.

Safety: It is the responsibility of the submitter to ensure that their specimens are not a hazard to transport or laboratory personnel. To protect the safety of others, the following precautions must be followed when collecting specimens:

- During specimen collection wear appropriate personal protective equipment.
- Use leak-proof containers and plastic zip-lock transport bags **that have a separate outside compartment for the test requisition form.**
- Make sure screw-cap lids are fastened evenly and securely. Ensure that no label material is caught in the threads of the lid.
- Do not transport leaking containers or use containers that do not close securely – these compromise test results and are a hazard to couriers and laboratory personnel.
- To protect the safety of others, take care not to contaminate the outside of the specimen container or the laboratory requisition form.

Specimen Labeling: Proper identification of every patient sample is as important as the quality of the sample and the precision of the laboratory. We will not test unlabeled or mislabeled specimens. Please follow these guidelines when collecting specimens:

- Clearly label the specimen container with the patient's name, date of collection, and Medical Record (MR) number or Date of Birth (DOB).
- **CLIA regulations require two (2) unique identifiers for each patient, either a name and birth date, or name and Medical Record number, on the specimen container and requisition form.**
- Check with the patient to make sure that you are collecting/drawing the right person.
- Verify the patient's name with the test requisition and container label after collection.

San Joaquin County Specimen Collection Guide

Specimen Collection: The patient specimen or collection site must be carefully selected so that it represents the active disease process and is not overly contaminated with indigenous microbial flora.

- Select the correct site and use the proper collection techniques.
- Collect the proper volume of specimen for the test; be aware that some tests are compromised by an excess of specimen.
- Collect specimens in the proper container; test results can be affected by preservatives and anticoagulants.
- Collect specimens using appropriate container for the test requested. See SJCPHL Test Request information for appropriate specimen to collect.
- Use media or collection containers with current expiration dates.
- San Joaquin County Public Health Laboratory provides the following collection kits supplies, contact laboratory for supply order form (See Appendix 1).
 - Hologic Aptima Chlamydia/Gonorrhea unisex swabs and urine specimen collection kits
 - Blood vacutainer tubes
 - Enteric collection kits
 - Laboratory forms
 - Nasopharyngeal swabs – dry
 - Ova & Parasite collection kits
 - Respiratory specimen collection kits – includes swab and Viral Transport media (VTM).
 - Specimen bags
 - Sputum collection containers
 - Stool collection containers
 - Urine collection containers
 - Viral Transport media (VTM)
- **Contact PHL for any collection supplies needed and for assistance @ 209-468-3460.**
- Specimen identification. **Label container with patient's last name and first name, date of specimen collection and type of specimen.**
- A completed laboratory requisition must accompany each specimen (Refer to page 5 for example, Lab forms are uploaded to http://www.sjcphs.org/disease/public_health_Laboratory.aspx)
Required information:
 - Patient's last and first name.
 - Medical Record number or Client ID
 - Patient's address
 - Patient's birthdate and gender
 - Date of specimen collection
 - Time of collection
 - Pregnancy status for females
 - Specimen source
 - Test requested
 - Submitter information, including address and physician name, **National Provider Identifier (NPI)**, phone number and fax number.
 - Billing information, such as, Medi-Cal or private insurance information.
- Cultures for Identification (CI's) are submitted using forms specific for bacteriology, mycology, or Mycobacteriology (see Appendix). Contact PHL for any questions on the forms if needed.
 - Note: All Salmonella isolates must be submitted to SJCPH Laboratory for typing and referral to the Statelab.
 - All initial *Mycobacterium tuberculosis* isolates must be referred to SJCPH Laboratory for identification, referral for genotyping to the State Laboratory and if necessary, drug susceptibility testing.

San Joaquin County Specimen Collection Guide

- Please refer to California Title 17 Code of Regulation 2500 and 2505 for further information on specimens which must be reported to Public Health Communicable Disease/Morbidity and which cultures must be submitted to the Public Health Laboratory.
<https://www.cdph.ca.gov/Programs/CID/DCDC/CDPH%20Document%20Library/LabReportableDiseases.pdf>
- Transport of specimens to SJPH Laboratory. Transport specimens at the required temperature. Mail or deliver specimens immediately after collection at the recommended transport conditions. The Laboratory address is:

**San Joaquin County Public Health
Laboratory 1601 E. Hazelton Ave.
Stockton, CA 95205
Telephone (209) 468-3460.**

The laboratory is open from 8:00 am to 5:00 pm, closed 12-1 pm for lunch, Monday through Friday (excluding holidays). Courier service may be provided upon request. Please contact the Public Health Laboratory at 209-468-3460 for questions regarding specimen transport. Email any urgent matters at phslabmgrs@sjcphs.org if unable to reach out via the phone.

Packaging and Shipping instructions:

- Currently clinical specimens are divided into three categories for shipping purposes.
 - Unregulated – Samples not known to contain any agent capable of infecting humans or animals.
 - Biological Substance – Category B (UN 3373) – Is defined as any clinical sample that does not meet the definition of Category A. In general, specimens in Category B are samples that are being sent for diagnostic purposes including virus isolates being shipped for further characterization. Patient samples are considered Category B and are defined as coming directly from humans or animals, including excreta, blood and components, tissue, tissue fluid, body parts for diagnostic or research purposes and disease prevention and treatment. Diagnostic shippers must be used for shipping category B.
 - Biological Substance – Category A (UN 2814) – Is defined as a substance or agent that is capable of causing permanent disability, life-threatening or fatal disease. This packaging must include a shipping Dangerous Goods Declaration, shipper must be certified as an Infectious substance shipper, and a 24/7 contact number must be provided. See the web site below for further information.

https://www.aphis.usda.gov/emergency_response/tools/transportation/htdocs/images/InfectSubstances.pdf

- Complete definitions for these three categories can be found at IATA Dangerous Goods Regulations (IATA1.0) and the Code of Federal Regulations (49 CFR 171.8). The rules and regulations are subject to change and more stringent rules can be established by any carrier. The following guidelines are for your convenience. Please contact the laboratory or your carrier for changes or requirements. The Public Health Laboratory may assist the submitter in selecting containers, contact 209-468-3460.

San Joaquin County Specimen Collection Guide

Diagnostic Shipping Container Packaging Information: Place the primary container (such as blood tube) in a secondary container, such as a zip lock bag with absorbent material (wrap specimen in paper towel). Place laboratory request form on the outside of secondary container, such as in outer pouch of zip lock bag. Do not place laboratory form around primary specimen container. Place secondary container in a Diagnostic shipping box with cushion material. Make sure the shipping box is properly addressed and has the required labeling, postage, shipping documents, as necessary. Some Diagnostic shipping containers have an additional plastic bottle; the specimens are placed in the secondary container, such as zip lock bag, and then placed into plastic bottle which is then placed into the Diagnostic shipping box. The box is sealed then addressed for shipping. These containers usually have labels for marking outside of the box as a "Diagnostic Specimen Container". Specimens that are hand delivered by courier may be placed in zip lock specimen transport bag and then in an outer crush resistant container. Contact laboratory for assistance.

- Courier Services. SJPH Laboratory may provide courier services within the city of Stockton. Contact thelaboratory for further information @ 209-468-3460.
- Training for sentinel laboratories: SJPHL encourages the Sentinel laboratory staff to sign up on the CDC train website to take the Packaging and Shipping.

<https://www.cdc.gov/labtraining?Sort=format%3A%3Aasc>

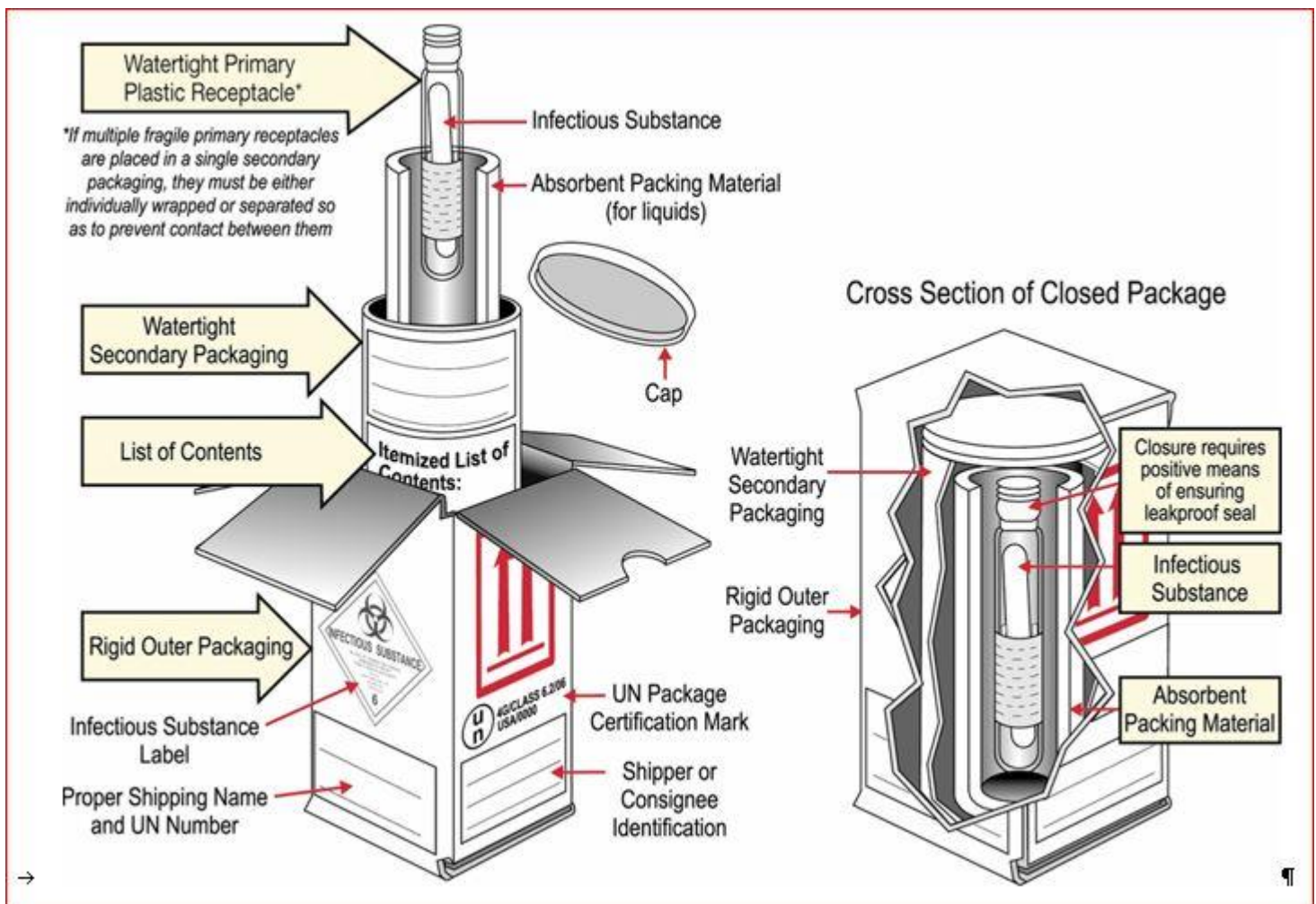

San Joaquin County Specimen Collection Guide

TEST REQUEST INFORMATION – Laboratory Test List Alphabetical

Test Name	CPT
AFB Culture (Concentrate & Isolation)	87015 & 87116
AFB Smear	87206
AFB Culture Blood/MAC/MAI	87116
Bacterial culture – Misc.	87070
Chlamydia NAAT test	87491
Diphtheria Culture	87070
Enteric Culture – Salmonella/Shigella/E. coli	87045
Enteric Culture Isolate ID	87045
Enterovirus NAAT	87798
Flavivirus NAAT*	-
Flu-SARS CoV-2 NAAT	87636
Fungus Culture	87102
Gastrointestinal Panel PCR (22 Targets) NAAT	87507
Hepatitis C Qualitative RNA NAAT	87521
Hepatitis C Quantitative RNA NAAT	87521
Herpes Simplex 1 and 2/VZV NAAT	87529x3
HIV 1 and HIV2 Antibody Screen - Serum	87806
HIV 1 Antibody confirmation	86701 & 86702
HIV 1 Quantitative RNA NAAT	87536
Influenza Screen NAAT	87502
Influenza Subtype NAAT	-
Measles NAAT*	87798
Mpox (Non-Variola Orthopox) NAAT	87798
Mumps NAAT*	87798
Mycobacteria CI reference ID	-
Neisseria gonorrhea culture	-
Neisseria gonorrhea NAAT	87591
Norovirus NAAT*	87798
Parasite Reference	-
Pertussis Culture	87070
Pertussis NAAT	87798
Respiratory Panel NAAT (22 Targets) NAAT	87633
Ova & Parasite Panel (Concentrate/Trichrome)	87177 & 87209
QuantiFERON TB Gold Plus	86481
RPR Qualitative	86592
RPR Quantitative	86593
Rubeola Antibody	86765
SARS-CoV-2 NAAT	
SARS CoV-2 WGS	
STEC/Shiga Toxin testing	87505
Treponemal Test (TPPA)	86780
Trichomonas NAAT	87661
Varicella NAAT	87798
VDRL	86592
West Nile Virus	86788 & 86789
Xpert Carba-R NAAT	87150
Xpert MTB/RIF NAAT	87556

* Measles, Mumps, Norovirus and Zika testing provided **only** by referral from Communicable Disease Division of SJCPH.

This list is not conclusive. If a particular test is desired and is not included in this guide, please call the Public Health Laboratory @ 209- 468-3460 for assistance.

Collection Guide

Bacteriology Services

DISEASE	TEST ⁽¹⁾	Specimen ⁽²⁾	Special Handling ⁽⁴⁾
Anthrax	Culture	Isolate	Immediately contact Public Health Laboratory @ 209-468-3460 if anthrax case suspected or if anthrax cannot be ruled out.
	PCR	Environmental and clinical specimens	Contact Public Health Laboratory or Public Health if there is a suspected release of anthrax or cases of anthrax are suspected. Not for routine testing.
Bordetella pertussis	Culture	Isolate	Culture of clinical specimens and direct testing of clinical specimens by PCR. Contact Public Health Laboratory prior to submission and for specimen collection kits.
	PCR	NP swab	NP swab in sterile tube or submitted in Regan Lowe media.
Brucellosis (Undulant Fever)	Culture	CI, Isolates	Contact Public Health Laboratory immediately . Specimens may be referred to CDPH-MDL for definitive identification.
	PCR	Environmental and clinical specimens	
Campylobacter	Culture	Stool	Submit specimens in Cary Blair transport media only. Specimens must be submitted within 4 days of collection.
	PCR	Stool	Submit specimens in Cary Blair transport media as soon as possible.
Chlamydia	NAAT	Genital, Urine, Rectal & Pharyngeal specimens	Amplified detection in cervical, urethral, urine, rectal and pharyngeal specimens for screening purposes only. Not recommended for medical legal instances. Culture recommended.
Cholera	Culture	Stool	Contact Public Health Laboratory prior to submission. Stool must be submitted in Cary Blair transport media.
	PCR		
Diphtheria	Culture	NP swab, Pseudo membrane, skin lesion	Contact Public Health Laboratory for Amies culture transport media.

Collection Guide

Bacteriology Services

DISEASE	TEST ⁽¹⁾	Specimen ⁽²⁾	Special Handling ⁽⁴⁾
E. coli O157-H7	Culture	Stool	Stool must be submitted in Cary Blair Transport Media. Contact Public Health Laboratory for specimen container.
		GN Broth	Shiga producing broths maybe submitted for confirmation or identification of non-O157 E. coli.
Food borne illness	Culture	Stool	Contact Communicable Disease Division prior to submission of specimens. All food related illness is evaluated epidemiologically prior to testing food or stool for pathogens.
		Food	Testing of food only at direction of Environmental Health and Communicable Disease Division of Public Health Dept.

Collection Guide

Bacteriology Services

DISEASE	TEST ⁽¹⁾	Specimen ⁽²⁾	Special Handling ⁽⁴⁾
Gastroenteritis	Culture	Stool	Enteric pathogens, such as, Salmonella, Shigella, EHEC, Stool must be submitted in Cary Blair transport media. Notify Public Health Communicable Disease Division.
		GN broth	For suspect EHEC, Shiga toxin testing maybe performed on request.
	PCR	Stool	Stool must be submitted in Cary Blair transport media. Notify Public Health Communicable Disease Division.
Gonococcal infections	Culture	Genital and non-genital sites	Isolates submitted for definitive identification or patients' Specimens are inoculated directly onto culture media.
	NAAT	Genital, Urine, Rectal, Pharyngeal specimens.	Amplified detection in cervical, urethral, urine, rectal and pharyngeal specimens for screening purposes only. Not recommended for medial legal instances. Culture recommended.
Infant Botulism	Toxin test	Stool	Contact Public Health Laboratory for collection and submission instructions prior to collection. Testing performed by the Infant Botulism Laboratory of the California Department of Public Health.
Legionnaire's Disease	Culture	Isolates	Pure culture isolates submitted to CDPH-MDL for definitive identification.
Leprosy (Hansen's Disease)	AFB Staining PCR	Skin Biopsy	Contact the National Hansen's Disease Program in Louisiana at: 1-800-642-2477 for assistance.
Plague	Culture	Blood Isolates, Bubo aspirates	Immediately contact Public Health Laboratory if a suspected case of pneumonic or bubonic plagues is suspected. Direct testing may perform if necessary or requested by Health Office for clinical and environmental samples.
	PCR	Environmental and clinical specimens	
Salmonellosis	Culture	Stool	Stool must be submitted in Cary Blair Transport Media. Contact Public Health Laboratory for specimen container.
		Isolate	Pure culture isolates submitted on agar slant for definitive identification, sero-grouping and serotyping.

Collection Guide

Bacteriology Services

DISEASE	TEST ⁽¹⁾	Specimen ⁽²⁾	Special Handling ⁽⁴⁾
Shigellosis	Culture	Stool Isolate	Stool must be submitted in Cary Blair Transport Media. Contact Public Health Laboratory for specimen container. Pure culture isolates submitted on agar slant for definitive identification, including sero-grouping.

Collection Guide

Bacteriology Services

DISEASE	TEST ⁽¹⁾	Specimen ⁽²⁾	Special Handling ⁽⁴⁾
Streptococcal infection	Culture	Throat swab & Isolates	Throat cultures for Beta-hemolytic Streptococci and identification. Contact the Public Health for culture containers.
Tuberculosis	Culture	Sputum, Respiratory, CSF, Lesions, Stool	Microscopic examination and culture for acid fast bacilli (AFB). Isolation and identification of <i>M. tuberculosis</i> or other Mycobacterium species. Rapid DNA probes assays available for <i>M. tuberculosis</i> complex, <i>M. avium</i> , <i>M. kansasii</i> and <i>M. gordonae</i> from culture isolates.
	NAAT (GeneXpert)	Raw or processed sputum and Bronch Wash specimens	Direct Amplification from AFB smear negative and positive respiratory samples* The GeneXpert MTB/RIF Assay is intended for use with patients who have received no anti-tuberculosis therapy, or less than 3 days of therapy.
	Pyrosequencing	Sputum sediments or solid or liquid culture isolates	Test performed by the California Department of Public Health Laboratory (MDL).
	Genotyping	Pure culture isolates of <i>M. tuberculosis</i>	Test performed by the Michigan Department of Community Health Tuberculosis Laboratory.
	Serology	Whole Blood	QuantiFERON-TB Gold Plus (QFT-Plus)
Tularemia	Culture	Isolates, Clinical specimens	Direct detection from clinical material and definitive identification of isolates. Immediately contact Public Health Laboratory if tularemia is suspected.
	PCR	Environmental and Clinical specimens	

Collection Guide

Bacteriology Services

DISEASE	TEST ⁽¹⁾	Specimen ⁽²⁾	Special Handling ⁽⁴⁾
Vibrio infections	Culture	Stool	Stool must be submitted in Cary Blair Transport Media. Contact Public Health Laboratory for specimen container.
	PCR	Stool	Stool must be submitted in Cary Blair Transport Media
Whooping Cough	Culture	NP Swabs	Nasopharyngeal swabs (NP) submitted in Regan Lowe transport media if both culture and PCR requested. Contact Public Health Laboratory for collection kits. See Bordetella pertussis above.
	PCR	NP Swabs	If only PCR request, then a NP swab may be submitted in a sterile tube without media. Contact Public Health Laboratory for collection kits.
Yersinia (See Plague)	Culture	Stool	Stool must be submitted in Cary Blair Transport Media. Contact Public Health Laboratory for specimen container.
	PCR	Environmental and clinical specimens	

Collection Guide

Parasitology Services

DISEASE	TEST ⁽¹⁾	Specimen ⁽²⁾	Special Handling ⁽⁴⁾
Amebiasis	Wet Mount & Stained Smear	Stool	Stool must be submitted in Ova & Parasite preservatives – 1 bottle each of PVA and Formalin. Contact Public Health Laboratory for containers and collection directions.
Enterobiasis	Direct exam	Peri-anal paddle	Contact laboratory for collection protocols (Perianal paddle not provided). Best collected early in morning before bathing.
Giardiasis	Wet mount & stained smears	Stool	Stool must be submitted in Ova & Parasite preservatives – 1 bottle each of PVA and Formalin. Contact Public Health Laboratory for containers and collection directions.
	PCR	Stool	Stool must be submitted in Cary Blair Transport Media.
Hookworm	Wet mount & stained smears	Stool	Stool must be submitted in Ova & Parasite preservatives – 1 bottle each of PVA and Formalin. Contact Public Health Laboratory for containers and collection directions.
Hydatid Disease (Echinococcosis)	Serology	Serum or Plasma	CDC offers limited serology. Contact Public Health Laboratory for instructions and containers.
Malaria	Direct staining	Blood smears	Microscopic examination of Giemsa-stained blood smears or whole blood collected in EDTA. Contact Public Health Laboratory for assistance.
Scabies	Direct exam	Skin scrapings	Direct examination of lesions scrapping for mites. Contact Public Health Laboratory or Public Health Clinic for examination.
Trichinosis	Serology	Serum	CDC provides on a limited basis, contact Public Health Laboratory for assistance.
Trichomoniasis	NAAT	Urine	Amplified detection in urine specimens for screening purposes only.

Collection Guide

Mycology Services

DISEASE	TEST ⁽¹⁾	Specimen ⁽²⁾	Special Handling
Candidiasis	Culture	Isolates	Definitive identification of yeast isolates. Contact Public Health Laboratory for assistance.
Coccidioidomycosis	Culture	Isolates or Clinical specimens	Contact Public Health Laboratory for assistance. Testing performed at the California Department of Public Health.
Dermatophytosis	Culture	Isolates or Clinical Samples	Culture of clinical specimens or identification of isolates. Contact Public Health Laboratory for instructions.
Mycotic Infection	Culture	Clinical specimens	Isolation and identification of organisms causing fungal mycoses. Clinical specimens include sputum, body fluids, pus, tissue, or other material. Contact Public Health Laboratory for collection assistance.
Ringworm (See Dermatophytosis)			

Collection Guide

Serology Services

DISEASE	TEST ⁽¹⁾	Specimen ⁽²⁾	Special Handling ⁽⁴⁾
HCV Viral Load	PCR	Serum or Plasma	Grossly Hemolyzed specimens should not be submitted. EDTA, heparin or citrate anticoagulants may be used to collect plasma specimens. Specimens should be separated from red blood cells and refrigerated within 4 hours of collection. Qualitative and Quantitative viral load test. Minimum of 2.0 ml of Plasma or Serum must be separated from RBCs within 4 hours of collection, store at 4°C for 4 days or freeze at -70°C.
HIV- Screening and confirmation	EIA	Serum or Plasma	Specimens should be separated from red blood cells and refrigerated within 24 hours of collection. Minimum volume: 100µL Serum/Plasma.
	Genius	Serum or Plasma	For confirmation of Serum and Plasma Specimens.
HIV Viral Load	PCR	Plasma	Collected with EDTA only. Minimum 2 ml of plasma. Specimens must be separated from red blood cells within 4 hours of collection. Plasma may be stored at 2-8°C for up to 4 days.
Measles (Rubeola)	EIA IgG	Serum or Plasma	Grossly hemolyzed, Hyperlipemic, heat inactivated, or contaminated specimens may give erroneous results. 200µL Serum/Plasma minimum.
	IgM		IgM testing done at CSDH-VRDL. Specimens should be separated from red blood cells and refrigerated within 24 hours of collection.
	PCR	Respiratory specimens, Urine	Testing of at direction of the Communicable Disease Division of the San Joaquin County Public Health Dept.

Collection Guide

Serology Services

DISEASE	TEST ⁽¹⁾	Specimen ⁽²⁾	Special Handling ⁽⁴⁾
SARS-COV2 virus	Serology	Serum or plasma (EDTA) specimens	The specimens can be stored at 2-8°C if the test is performed within 4 days. If the test cannot be completed within 4 days, freeze the specimens at -20°C or colder.
Syphilis	RPR	Serum	Non-treponemal screening test. Grossly hemolyzed, Hyperlipemic, heat inactivated, or contaminated specimens may give erroneous results. Specimens should be separated from red blood cells and refrigerated within 24 hours of collection. 150µL Serum minimum.
	TP-PA	Serum	Confirmatory assay for RPR. 50µL Serum minimum.
	VDRL	CSF	Clear, non-hemolyzed spinal fluid required for test. Hemolyzed CSF may give erroneous results. 150 µL CSF minimum
TB – QuantiFERON Gold-Plus	Serology	Whole blood	Whole Blood submitted in QTB In-Tube-Plus tubes (Grey, Yellow, Purple, and Green). Vacutainers provided by Public Health. Laboratory only. Specimens must be received at Public Health. Laboratory by 3 pm Monday thru Thursday, must be processed within 16 hours of collection. Contact Public Health Laboratory for collection protocol and collection kits.
West Nile Virus (WNV)	IFA	Serum	Grossly hemolyzed, Hyperlipemic, heat inactivated, or contaminated specimens may give erroneous results. Specimens should be separated from red blood cells and refrigerated within 24 hours of collection. Minimum of 150 µL serum is required.

Collection Guide

Virology Services

DISEASE	TEST ⁽¹⁾	Specimen ⁽²⁾	Special Handling ⁽⁴⁾
Arboviruses: WEE, SLE, WNV	Serology (IgM, IgG)	Serum, CSF	WNV serological testing is performed by the San Joaquin County Public Health laboratory. Testing for WEE & SLE is offered through the CSDH-VRDL only during mosquito season. CSF testing not available unless serum sample is positive and is also provided by CSDH-VRDL.
Arboviruses: Zika, Dengue, Chikungunya	PCR	Serum, Whole Blood, CSF	<p>Testing requests at direction of the Communicable Disease Division of the County Public Health Dept.</p> <p>Urine and Amniotic fluid specimens are acceptable for Zika virus.</p>
Enterovirus (Respiratory)	PCR	Respiratory, CSF	PCR for Enterovirus. Submit specimens in Viral Transport Media.
Gastroenteritis	PCR	Stool in Cary Blair	Multiplex PCR for Campylobacter, Clostridium difficile Toxin A/B, Plesiomonas shigelloides, Salmonella, Vibrio, Yersinia enterocolitica, Enterohaggative E. coli (EAEC), Enteropathogenic E. coli, (EPEC), Enterotoxigenic E. coli, (ETEC), Shiga-like toxin-producing E. coli (STEC), Shigella/Enteroinvasive, E. coli (EIEC), Cryptosporidium, Cyclospora cayetenensis, Entamoeba histolytica, Giardia lamblia, Adenovirus F 40/41, Astrovirus, Norovirus GI/GII, Rotavirus A, and Sapovirus.
Herpes simplex	PCR	Vesicular lesion	Isolation and PCR from vesicular lesions, swabs collected in VTMan and stored @ 4°C and submitted to laboratory within 48 hrs of collection.

Collection Guide

Virology Services

DISEASE	TEST ⁽¹⁾	Specimen ⁽²⁾	Special Handling ⁽⁴⁾
Influenza	Serology	Serum	Serology offered on acute (<7 days onset) and convalescent (14 day post-acute) at CSDH-VRDL. Contact Public Health Laboratory.
	Screening PCR	NP, Throat swabs	Screening PCR for Influenza A and Influenza B
	Typing PCR	NP, Throat swabs	Influenza A subtyping PCR
Measles	PCR	Throat, Nasal or NP swab	Testing at direction of the County Communicable Disease Division of Public Health Dept.
		Urine specimen	
Mpox (Non-Variola Orthopox)	PCR	Lesion swab x2	Call for testing 209-468-3460
Mumps	PCR	Buccal/Oral swab	Testing at direction of the County Communicable Disease Division of Public Health Dept.
		Urine specimen	
Norovirus	PCR		PCR for Norovirus on outbreaks only. Testing of at direction of the Communicable Disease Division of Public Health Dept.

Collection Guide

Virology Services

DISEASE	TEST ⁽¹⁾	Specimen ⁽²⁾	Special Handling ⁽⁴⁾
<p>Rash illness</p>	<p>Serology</p>	<p>Serum</p>	<p>Measles (Rubeola Virus) IgG ELISA test is intended for immunity screening and for diagnostic testing.</p>
	<p>PCR</p>	<p>Vesicle scrapping</p>	<p>Identify vaccine related illnesses, such as Vaccinia. Offered for varicella zoster virus. Immediately contact Public Health Laboratory if Smallpox suspected.</p>
	<p>PCR</p>	<p>NP swab, urine</p>	<p>Measles and/or other rash illness PCR upon referral from Public Health Communicable disease.</p>
<p>Respiratory Panel</p>	<p>PCR</p>	<p>NP swab</p>	<p>Use Viral Transport Media. Multiplex PCR for Adenovirus, Coronavirus 229E, Coronavirus HKU1, Coronavirus NL63, Coronavirus OC43, SARS-Cov-2, Human Metapneumovirus, Human Rhinovirus/Enterovirus, Influenza A, Influenza B, Parainfluenza Virus 1, Parainfluenza Virus 2, Parainfluenza Virus 3, Parainfluenza Virus 4, Respiratory Syncytial Virus, Bordetella parapertussis, Bordetella pertussis, Chlamydia pneumoniae, and Mycoplasma pneumoniae.</p>
<p>SARS-COV2 virus</p>	<p>PCR</p>	<p>NP swab, OP swab, Nasal Swab in VTM</p>	<p>Store COVID specimens at 2-8°C for up to 72 hours after collection. If a delay in testing or shipping is expected, store specimens at -70°C or below.</p>

Collection Guide

Virology Services

DISEASE	TEST ⁽¹⁾	Specimen ⁽²⁾	Special Handling ⁽⁴⁾
Varicella zoster virus (VZV)	PCR	Lesion Swab	Use Viral Transport Media
Viral hemorrhagic fevers	Serology	Serum	CDPH-VRDL offers specialized testing on a case-by-case basis. Contact Public Health Laboratory for guidance. Case history form must accompany request that includes travel information.

- (1) DFA = Direct Fluorescent Antibody test
 EIA = Enzyme immunoassay
 IFA = Indirect Fluorescent Antibody Test
 NAAT = Nucleic acid amplification test
 Non-Treponemal Tests = RPR Card Test; VDRL Slide Test
 PCR = Polymerase Chain Reaction
 RPR = Rapid Plasma Reagin Test
 TP-PA = Treponema pallidum Particle Agglutination test
 Treponemal Tests = FTA-ABS Test; TP-PA Test
 VDRL = Venereal Disease Research Lab, test for Syphilis

- (2) Serum, plasma or whole blood, or CSF (Cerebral spinal fluid), Eye = Conjunctival swab, NP = Nasopharyngeal swab
- (3) CI = Culture for Identification, Isolate submitted for definitive identification
- (4) Description of collection tubes and kits are in “Specimen Container Guide” section of this Service Manual for more information.

Information on Viral Disease and Agents

A.I.D.S (HIV) Virus Antibody Tests

The routine antigen/antibody test is an EIA test which is repeated in duplicate if the initial test is reactive. All reactive serum specimens also have a confirmatory test performed. HIV viral load testing is also available for the confirmation of early disease where the antigen portion of the HIV screening test was positive.

Arbovirus tests

Serological tests for West Nile Virus (WNV), Western equine encephalomyelitis (WEE) and St. Louis encephalitis (SLE) are performed for cases of encephalitis or aseptic meningitis with onset of illness from May through October. During November through April, human diseases due to these mosquito-borne viruses are not known to occur in California. Dengue, California encephalitis (CEV), Eastern equine (EEE) and Japanese B encephalitis are not endemic in California. Serologic tests are performed only if exposure history indicates exposure in known endemic areas. Contact Public Health Laboratory for information of specimen collection and submission.

Cerebrospinal Fluid Antibodies

CSF specimens can be tested for antibody, for virus isolation or both depending on a number of factors such as agents suspected, onset date relative to collection date and availability of test. CSF specimens taken within a few days of the date of onset are usually of more value for virus isolation or direct antigen detection by PCR. This is especially true when there is a corresponding blood specimen that can be tested for antibodies. CSF specimens that are contaminated with blood are not satisfactory for antibody testing; virus isolation may be attempted if possible. If no antibody is detected in the serum sample, the CSF specimen will not be tested. If antibody is detected in the blood specimen, then the CSF specimen may be tested for antibody. In either case, testing of CSF for antibodies is usually of no diagnostic value if serum antibody levels are low or absent. Since CSF may also be tested for virus isolation, ship CSF on ice.

Chlamydia Infections

The chlamydiae of importance in human disease are of 3 species. *Chlamydia psittaci*, which may cause psittacosis in humans, has a reservoir or natural cycle in pigeons, turkeys and other birds; *Chlamydia trachomatis* (various serotypes) and *Chlamydia pneumonia* (TWAR). The spectrum of *Chlamydia trachomatis* infection includes lymphogranuloma venereum (LGV) (3 serotypes), trachoma, inclusion conjunctivitis (newborn and adult), pneumonitis of infants, non-gonococcal urethritis, cervicitis, and other sexually transmitted disease syndromes. [San Joaquin County Public Health Laboratory has testing availability for *Chlamydia trachomatis* infection using Nucleic Acid amplification tests \(NAAT\) on cervical, urethral, urine, rectal and pharyngeal specimens.](#)

[Isolation of *C. trachomatis* is recommended for medical-legal reasons](#), such as, for testing of specimens from criminal or abuse cases or from minors. Contact PH Laboratory for collection kits and guidelines for submission of specimens.

Colorado tick fever – Testing by State Laboratory Only

Colorado tick fever is endemic in California counties of Modoc, Siskiyou, Shasta, Lassen, Plumas, Sierra, Nevada, Placer, El Dorado, eastern Calaveras, Alpine, eastern Tuolumne, and Mono, and in eastern Oregon, Nevada, Idaho, Utah, Montana, Wyoming, and Colorado, parts of Canada and a few other western states. It is only transmitted by tick bite and is most prevalent from March to September. Unless there has been a tick bite or exposure in an endemic area, testing for the disease is not generally warranted.

Acute and convalescent bloods should be collected. If the acute specimen is submitted as a whole blood, the blood clot is tested for evidence of virus by direct immunofluorescence. The immunofluorescence test for Colorado tick fever may be negative on blood samples taken in the first few days of illness, even when virus is present, testing of convalescent blood or specimens collected later in illness is necessary. Positive results are reported as soon as positive.

Viremia (period of time virus is in the blood) has been shown to be unusually long in Colorado tick fever, up to three or four months, even though the patient is fully recovered clinically. Although this is of no apparent harm to the patient, he/she should be advised not to serve as a blood donor for at least six months after recovering from the symptoms of the disease, since transmission of the virus to the blood recipient might occur.

Coxsackievirus and Echovirus Infections

Rapid PCR methods are available upon request or in instances of an outbreak or in cases having clinical or epidemiological significance. Contact Public Health Laboratory for specimen collection and submission.

Epstein-Barr (EBV) TESTS – Testing by State Virus Lab Only

Testing Policy - Serologic tests for Epstein-Barr virus is usually performed to help diagnose cases with infectious mononucleosis-like symptoms (fever, sore throat, lymphadenopathy, atypical lymphocytes) but where heterophile antibody could be demonstrated. If possible, cytomegalovirus, *Toxoplasma gondii* and adenovirus should be ruled out as causative agents before EBV testing. The CDPH-VRDL offers serologic testing for EBV, the combination of VCA IgG, VCA IgM and EBNA antibodies usually provides a good indicator of when a patient was infected.

Presence of antibody to both VCA and EBNA in an acute or convalescent serum is thus indicative of past EBV infection. Presence of IgM antibody to VCA together with lack of antibody to EBNA is consistent with recent EBV infection. A rising titer of antibody to VCA between acute and convalescent sera also indicated recent EBV infection. IgG and IgM antibodies to VCA, and IgG antibody to EBNA, are occasionally present together in late acute serum specimens from patients with EBV infection. However, since VCA-IgM antibody has been shown to be stimulated occasionally in other diseases, this pattern should be interpreted with caution.

Presence of VCA-IgG antibody and absence of IgM and EBNA antibody may indicate infection within the last six months since EBNA antibody is slow to appear. However, in rare instances, EBNA antibody from a long past EBV infection may not be demonstrable.

Gastroenteritis, Viral Diarrhea

Rotavirus is the leading cause of gastroenteritis among children 3 to 15 months old. Most children have been exposed to the virus by age 2. Children with rotavirus have vomiting and watery diarrhea for 3 to 8 days, along with fever and abdominal pain. Rotavirus can also infect adults who are in close contact with infected children, but the symptoms in adults are milder. Symptoms of rotavirus infection appear 1 to 2 days after exposure. In the United States, rotavirus infections are most common from November to April. Adenovirus serotypes 40 and 41 cause gastroenteritis mainly in children younger than 2 years old. Infections occur all year round; vomiting and diarrhea appear approximately 1 week after exposure. Caliciviruses cause infection in persons of all ages.

This family of viruses is further divided into the Noroviruses (example, Norwalk virus) and the Sapoviruses (example, Sapporo virus). Noroviruses are transmitted from person to person and through contaminated water or food and are often responsible for epidemics of viral gastroenteritis. Symptoms appear with 1-3 days of exposure and include vomiting, diarrhea, and muscle aches. Astrovirus also infects primarily infants, young children, and the elderly. This virus is most active during the winter months. Vomiting and diarrhea appear within 1 to 3 days of exposure. Rapid methods are available for norovirus detection from stool.

Hepatitis C

San Joaquin County Public Health Laboratory performs testing to detect the presence of HCV RNA in blood (Hepatitis C Qualitative RNA) as well as to quantitate the amount of HCV RNA in the blood (Hepatitis C Quantitative RNA) using a nucleic acid amplification test.

Influenza Virus

PCR detection is available at the Public Health Laboratory for Influenza A and B virus as well as subtyping of Influenza A and B virus. Contact Public Health Laboratory for further information. Serologic testing of acute and convalescent specimens is available through the state VRDL.

Mpox

Mpox is a rare disease caused by a virus from the same family as the virus that causes smallpox. Mpox symptoms are like smallpox, but milder, and Mpox is rarely fatal.

Rhinovirus

Serologic tests for rhinovirus infections are not available since over 100 distinct serotypes exist and each produces specific antibody. **PCR is used for the detection** of the virus from the throat and nasopharyngeal specimens.

Rickettsial Serological Tests

The IFA assay is generally considered the standard and is available through the CDPH-VRDL to test Rickettsia endemic in California - Q fever, Typhus, and Rocky Mountain spotted fever - as indicated by the clinical syndrome. Specific rapid laboratory confirmation of rickettsial disease is rarely done. Therefore, treatment decisions should be based on epidemiologic and clinical clues and should never be delayed while waiting for confirmation by laboratory results. For rickettsial agents, the value of testing two sequential sera together to show a rise in antibody level is very important to confirm acute infections because antibody titers may persist for years in individuals after the initial exposure.

Cross reactivity is common among rickettsial antigens. Paired serum specimens (acute and convalescent) in the course of the disease are the preferred specimens. Typically, these specimens should be taken at least 2-3 weeks apart. Contact Public Health Laboratory for specimen collection and other questions regarding rickettsial testing.

SARS-CoV-2

COVID-19 (coronavirus disease 2019) is a disease caused by a virus named SARS-CoV-2. It is part of the coronavirus family, which include common viruses that cause a variety of diseases from head or chest colds to more severe (but rarer) diseases like severe acute respiratory syndrome (SARS) and Middle East respiratory syndrome (MERS). SJCPHL performs molecular detection of SARS COV2 in upper respiratory tract samples. Any other sample type not validated on the platform will be forwarded to the state laboratory -VRDL or CDC.

Smallpox Virus

For suspected smallpox or other Orthopox virus infections contact Public Health Laboratory and Communicable Disease Division **immediately** for specimen testing guidelines. Specimens may be submitted to rule out varicella and other vesicular lesion producing viral diseases. Since Smallpox has not been seen a naturally occurring disease syndrome it is now considered as a possible agent of Bioterrorism. California State Department of Health and Center for Disease Control will handle all investigations into credible threats of Smallpox.

Viral Hemorrhagic Fevers

The etiologic agents may include Lassa fever, Marburg, Ebola, Hantavirus, yellow fever, and Dengue can all cause viral hemorrhagic fever (VHF). Sin Nombre Virus the causative agent of Hantavirus Pulmonary Syndrome (HPS) is endemic in California however the incidence of human infection is rare. Occasionally Dengue is seen from South America, Caribbean countries and may be implicated disease in patients who have traveled to endemic countries. Dengue has been seen in Texas. All other hemorrhagic fevers are seen in Africa and Asia and not on the US continent. California State Department of Health offers specialized testing on case-by-case bases; all requests must be accompanied by a case history form that includes travel to an endemic area. All suspected VHF must be reported to Public Health **immediately**.

SPECIMEN CONTAINER GUIDE

Sterile Specimen Cups

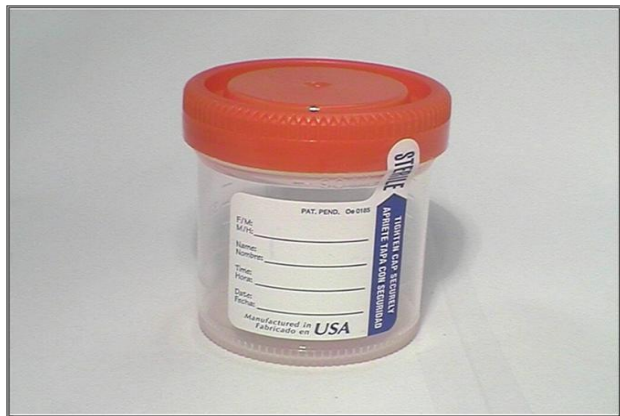

Sterile Specimen Cup:

Please label specimen container before giving it to the patient.

Intended use:

- AFB sputum, AFB urine, AFB tissue, AFB Stool, AFB bronchoalveolar lavage and bronchial washings.
- Chlamydia/GC Urine specimens.
- Mumps/Measles: Urine specimens

Specimen Type	Minimum Volume	Device Volume	Transport Time	Transport Temp (°C)	Comments
Acid-Fast Bacilli (AFB)					
Sputum	5 ml	5-10 ml	Within 24 hrs, refrigerate if longer.	4°C	Specimen is stable at 4°C for 5 days, specimens received after 5 days not satisfactory.
Urine	10 ml	10-20 ml non-preserved			
Stool	≥1 g	≥ 1 g non-preserved			
Bronchoalveolar Lavage Fluids and Bronchial Washings	≥5 ml	≥ 5 ml			
Gastric Lavage Fluids	5 ml	5-10 ml	Received by lab within 4 hours of collection. Must Neutralize pH within 4 hours of collection.	4°C	Specimen is stable at 4°C for up to 4hours. Specimens must be received by laboratory within 4 hours of collection. Specimens received after 4 hrs. will be tested but will be qualified as "Specimen not neutralized within 4 hrs may affect results."
Body Fluids (CSF, Pleural, peritoneal, and pericardial)	≥ 2 ml	≥ 2 ml	Within 24 hrs. of collection	4°C	Specimen is stable at 4°C. Ideally specimens should be received within 24 hrs.
Tissues (Lymph node, skin, another biopsy material)	≥ 1 g	≥ 1 g			
Chlamydia/GC NAAT					
Urine	10 ml	10-15 ml	24 hr. at Rm Temp. or 4°C.	25°C Room Temp	Add 2 ml urine specimen to Aptima collection kit. Indicate date/time collected if not put into Aptima Urine collection kit.
Mumps/Measles NAAT					
Urine	10 ml	20 ml	Process or store and ship at 2°-8° within 24 hours 4°C.	2°-8°C	Centrifuge 500-600 x g for 10 minutes. Resuspend pellet in 2-3 ml of viral transport media.

Blood Tube for AFB



Blood Transport Tubes withSPS (Sodium polyethylene sulfonate):

Intended Use:

- AFB Blood cultures **only**

Specimen Type	Minimum Volume	Device Volume	Transport Time	Transport Temp (°C)	Comments
Acid-Fast Bacilli (AFB) Blood Specimen	≥1 ml	≥1 ml	Collect blood into SPS tube.	25°C	Indicate specimen source. Collect in SPS or heparin as an Anticoagulant: EDTA or coagulated blood is not acceptable.

APTIMA Collection Device Overview



APTIMA Chlamydia and Gonorrhoeae collection devices:

Unisex device shown on left.
Urine collection device shown on right.

Hologic Aptima Endocervical and Male Urethral Swab Collection Kit (Unisex) and Aptima Urine Collection Kit.

Intended use: Chlamydia, Gonorrhea and Trichomonas NAAT

Specimen Type	Minimum Volume	Device Volume	Transport Time	Transport Temp (°C)	Comments
Chlamydia, N. gonorrhoeae Endocervical, Male Urethral, Throat and rectal specimens	1 swab	Aptima Swab – use blue swab only for collection.	Immediately place swab in transport tube	25°C Room Temp	Indicate specimen source.
Chlamydia, N. gonorrhoeae, Trichomonas Urine specimens	≥ 2 ml	~ 2 ml	24 hrs @ RT prior to addition to Aptima Urine collection Kit.	4°C to 25°C Room Temp	Use pipette provided with kit to add ~ 2 ml of urine to Aptima Urine Collection Kit

APTIMA Unisex Swab

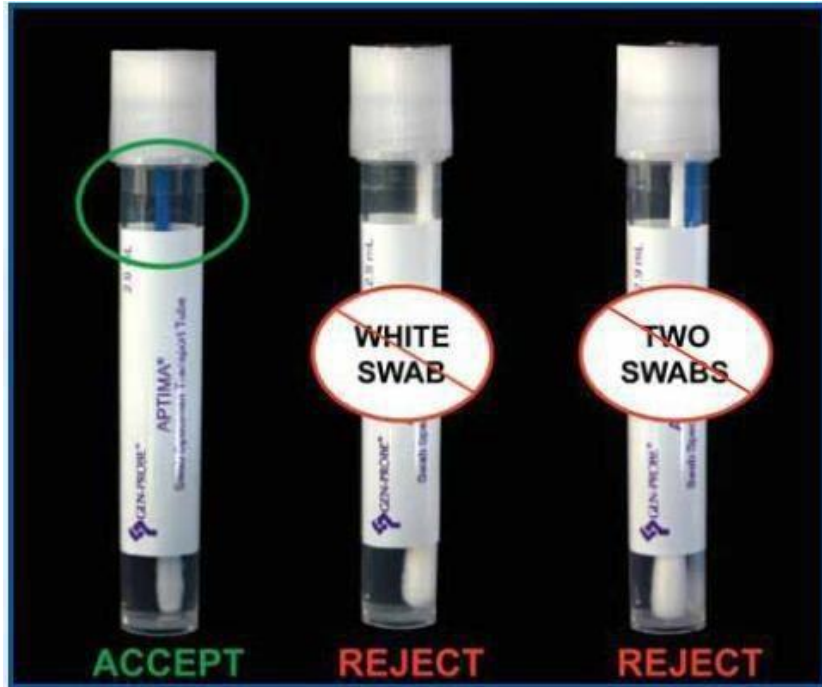

BLUE SWAB = Male Urethral and Female Endocervical Specimen Collection

WHITE SWAB = Female cleaning swab ONLY!

NOT FOR COLLECTION! DISCARD AFTER USE.

BLUE SWAB	ACCEPT
WHITE SWAB	REJECT
TWO SWABS	REJECT

APTIMA Urine Collection Device

Instructions:

Use the sterile transfer bulb provided in collection kit.

Transfer ~ 2.0 ml of well mixed urine to collection tube.

Urine volume should be between these two lines and will be visible in the window of tube.

Insufficient or overfilled tubes will not be tested.



Viral Transport Media



M4-RT Transport Media or Equivalent: (Dacron Swabs)

Intended use:

- Enterovirus PCR
- Herpes PCR
- Influenza PCR
- Measles PCR
- Mumps PCR
- Respiratory Panel PCR
- SARS-COV2 PCR
- VZV PCR
- Mpox PCR

Ova and Parasite Collection Device



MCC Total-Fix:

Please label specimen container before giving to the patient.

Intended use:

- Preservative and transport for Ova and Parasite examination of stool.

Specimen Type	Minimum Volume	Device Volume	Transport Time	Transport Temp (°C)	Comments
Feces Ova & Parasites (O&P) Screen and Giardia EIA	2.5 ml per bottle	Add specimen to black line on the container immediately after collection. Do not fill <u>entire</u> container.	Within 24-48 hrs.	25°C	Collect a total of 2 specimens, 1 specimen every other day. If patient has persistent symptoms suggesting intestinal parasitism, or is immunodeficient, and/or has history of travel from tropical areas, it is recommended that additional specimens be collected over a 7-10-day period. This would maximize the recovery of the protozoa.

Enteric Collection Device



Cary Blair Enteric Transport Media:

Please label specimen container before giving to patient.

Intended use:

- Preservative and transport for enteric pathogens – bacteria in stool.

Specimen Type	Minimum Volume	Device Volume	Transport Time	Transport temp (°C)	Comments
Feces Routine culture	2.5 ml per vial	Add specimen to black arrow on container. Do not fill <u>entire</u> container.	Add stool immediately after collection to Cary Blair transport and mix. 24-48 hrs	25°C if < 24 hrs, refrigerate if longer	For routine diagnosis of enteric pathogens. Specimens received ≥ 5 days after collection will not be tested.
Feces Gastrointestinal PCR Panel	2.5 ml per vial	Add specimen to black arrow on container. Do not fill <u>entire</u> container.	Add stool immediately after collection to Cary Blair transport and mix.	At room temperature for up to 4 hours (15-25 °C) Refrigerated for up to 4 days (2-8 °C)	For molecular identification of bacteria, parasites, and viruses.

Pinworm Paddle

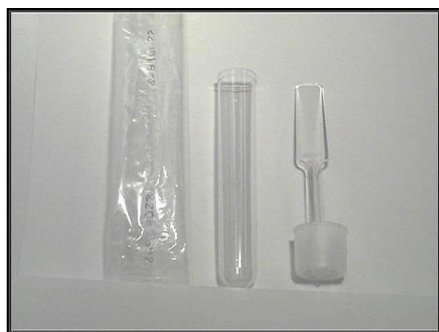

Pinworm Paddle:

Intended Use:

- Collection kit for detection of pinworm – *Enterobius vermicularis*.

Specimen Type	Minimum Volume	Device Volume	Transport Time	Transport Temp (°C)	Comments
Pinworm	N/A	Pinworm paddle kit: no preservative, no minimum volume required	≤ 24 hours	25°C	Common parasites include: <i>Enterobius vermicularis</i> , <i>Taenia</i> spp.

Specimens are best obtained at 10 to 11 p.m. or upon waking and before a bowel movement or bath. Press sticky side to both side of the perianal region, do not insert paddle into anus. Place paddle back into transport tube and into zip lock bag. Wash hands immediately after collection. Specimen collection should continue daily for at least 3 consecutive days before patient is considered infection-free. Transport to lab as soon as possible after collection.

B. pertussis Swab



Dacron or Flocked NP swab & Sterile tube (for aspirates only):

Intended use:

- For detection of *Bordetella pertussis* from nasopharyngeal swabs (NP) by culture and/or PCR (nucleic acid amplification).
- NP aspirates submitted in sterile tube.

Specimen Type	Minimum Volume	Device Volume	Transport Time	Transport temp (°C)	Comments
Pertussis Culture	1 swab or ≥1 ml	Dacron swab in Regan-Lowe Transport media	≤ 24 hrs.	RT, protect from excessive heat or cold	Collect specimens as soon at start of symptoms and prior to antibiotic therapy, If culture requested, please contact PHL for Regan-Lowe transport media.
Pertussis by PCR	1 swab or ≥1 ml	Dacron swab or ≥1 ml fluid in Sterile Tube		4°C	

Indicate specimen source on tube. Usual sites of collection are respiratory, include Nasopharyngeal swab, NP washing and Aspirates. For NP washing, if greater than 2 hours it should be stored under refrigeration. For NP wire swab, tilt patient's head back slightly and insert the swab into one of the nostrils until it reaches the posterior nares. Leave swab in place for 15-30 seconds then withdraw and return to tube. If culture is requested place swab into Regan-Lowe transport media tube for culture and PCR. For PCR test only, place swab back in original container. Transport to laboratory within 24 hours.

QuantiFERON-TB Gold Collection Tubes



QuantiFERON-TB Gold Plus Blood Collection tubes:

Intended use:

- Indirect test for the detection of *Mycobacteria tuberculosis* infections.
- Used in conjunction with risk assessment and other medical evaluations.

Specimen Type	Minimum Volume	Device Volume	TransportTime	Transport temp (°C)	Comments
QuantiFERON tubes	1 ml whole blood per tube	QTB Vacutainers collect 1 ml	Must be received by lab within 16 hrs of collection.	25°C	Underfilling or over filling of Vacutainers or improper mixing of blood with tube coating will invalidate test.

N. gonorrhoeae Collection Swab for Culture



**BactiSwab:
(Modified Stuart’s Media):**

Intended use:

- *Neisseria gonorrhoeae* (GC) culture collection/transport device.

Specimen Type	Minimum Volume	Device Volume	Transport Time	Transport Temp (°C)	Comments
<i>N. gonorrhoeae</i>	1 swab	Only Use Swab provided in kit.	Immediately push swab into gel in the tube after collection	25°C Transport to laboratory within 24 hrs.	Indicate collection site. Neisseria species are sensitive to cold conditions. Longer than 14 hrs may affect results.

Serology Collection Tube



Vacutainer Serum Separator Tube:

Intended use:

- Collection of blood for various serology tests requiring Serum specimen.

Specimen Type	Minimum Volume	Device Volume	Transport Time	Transport Temp (°C)	Comments
Serum	2 ml	7 ml draw	Transport to laboratory within 3 days of collection	4°C RT if < 24 hrs.	If longer than 3-day transport, if possible, centrifuge specimen to separate serum from blood cells. Transport and store at 4°C.

Measles

Measles Testing at San Joaquin County PHL

Health care providers within San Joaquin County must contact the San Joaquin County Public Health Department for measles virus consultation and testing approval at 209-468-3822 or 953-7506. After 5 P.M., please call 468-6000 and ask for the standby PHS nurse. Health Care providers outside San Joaquin County should contact their local Public Health Department for testing approval.

Symptomatic patients:

San Joaquin County Public Health Laboratory can perform a measles PCR test for confirming an acute case. Collection of both a respiratory swab (Throat, Nasal, or NP) and urine within 2 weeks of the rash onset improves the odds of detecting viral RNA.



M4-RT Transport Media or Equivalent & Dacron Swabs:

Intended use:

- Measles PCR

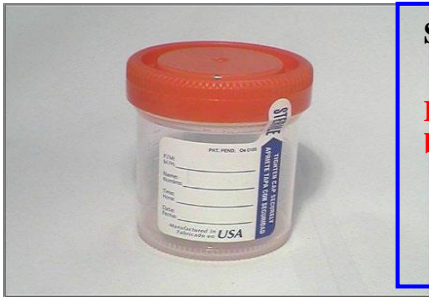

SPECIMEN BOTTLE

Please label specimen container before giving it to the patient.

Intended use:

- Urine specimen for Measles PCR.

Contacts:

IgG testing can be done on case contacts to determine prior exposure to the virus.



Vacutainer Serum Separator Tube

Intended use:

- Measles IgG

Mumps

Mumps Testing at San Joaquin County PHL

Health care providers within San Joaquin County must contact the San Joaquin County Public Health Department for measles virus consultation and testing approval at 209-468-3822 or 953-7506. After 5 P.M., please call 468-6000 and ask for the standby PHS nurse. Health Care providers outside San Joaquin County should contact their local Public Health Department for testing approval.

Symptomatic patients:

San Joaquin County Public Health Laboratory can perform a Mumps PCR test for confirming an acute case. Collect both a buccal or oral swab and urine specimen (for patients with orchitis) within 3 days of symptom onset.



M4-RT Transport Media or Equivalent & Dacron Swabs:

Intended use:

- Mumps PCR

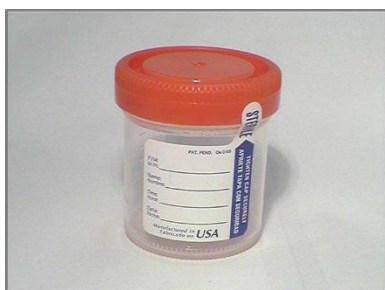

SPECIMEN BOTTLE

Please label specimen container before giving it to the patient.

Intended use:

- Urine specimen for Mumps PCR.

Contacts:

IgG and IgM testing is available at the California Department of Public Health



Vacutainer Serum Separator Tube

Intended use:

- Mumps IgG/IgM

Monkeypox

Mpox Testing at San Joaquin County PHL

Health care providers within San Joaquin County must contact the San Joaquin County Public Health Department for measles virus consultation and testing approval at 209-468-3822 or 953-7506. After 5 P.M., please call 468-6000 and ask for the standby PHS nurse. Health Care providers outside San Joaquin County should contact their local Public Health Department for testing approval.

San Joaquin County Public Health Laboratory can perform a PCR test for confirming Mpox. Patients must present firm, deep seated, and umbilicated skin lesions consistent with Monkeypox or other orthopoxvirus.



Viral Transport Media (Optional) & two Dacron, polyester, or nylon swabs. Two swabs required for each lesion.

Intended use:

- Mpox (Non-Variola Orthopox) PCR

Specimen Type	Minimum Volume	Device Volume	Transport Time	Transport Temp (°C)	Comments
Lesion	2 swabs for each lesion. Collect paired specimens from 2-3 lesions.	Vigorously swab or brush lesions	Transport to laboratory at 2-8°C. within 24-72 hours.	2-8°C for up to 72 hours.	If delay in testing or shipping, then -80°C or colder.

SARS-CoV-2

COVID Collection guidance for upper respiratory specimens for SARS-CoV-2 (COVID-19) molecular (NAAT) testing.

Swabs should be placed immediately into a sterile transport tube containing 2-3mL of either viral transport medium (VTM), Amies transport medium, or sterile saline.

COVID Specimen Type	Minimum Volume	Acceptable VTM	Transport Time	Transport Temp (°C)	Comments
Upper Respiratory Tract NP (preferred) OP swab in VTM/saline	2-3 ml	Remel MicroTest M4, M4RT, M5 or M6 formulation BD Universal ViralTransport Medium, Saline	Immediately place swab in the VTM tube after collection	Transport to laboratory within 72h at 4°C	Transport specimens at -70°C or below if longer than 72 hrs.

Storage: Store COVID specimens at 2-8°C for up to 72 hours after collection. If a delay in testing or shipping is expected, store specimens at -70°C or below.

Swab sample collections

- Use only sterile Dacron®, polyester, nylon, or rayon swabs with plastic shafts. Wired shaft swabs are acceptable but must be trimmed using sterile scissors.
- 3D-printed swabs are not acceptable.
- Note the stem/shaft must be flexible and long enough to collect the NP sample.
- If the applicator handle requires additional trimming, it is also important to perform the trimming with a sterile pair of scissors to prevent contamination of the sample.

The **Nasopharyngeal (NP)** swab is the most preferable sample type with the current testing platforms at SJCPHL; other acceptable types include Oropharyngeal (OP) and Nasal samples.

WARNING: Media containing guanidine thiocyanate or similar chemicals, including Longhorn PrimeStore MTM, Zymo DNA/RNA Shield, as well as that found in the Spectrum Solutions Saliva Collection Device, should not be used with in vitro diagnostic platforms at SJCPHL that use bleach (sodium hypochlorite) in the testing platform or during laboratory processes. Media containing guanidine thiocyanate or similar chemicals produce a potentially hazardous chemical reaction that releases cyanide gas when exposed to bleach. Many laboratories may use bleach in their cleaning or decontamination processes in response to laboratory spills. If the type of transport media cannot be identified in the specimen collection tubes or if it is unknown that the transport media contains guanidine thiocyanate or similar chemicals as an ingredient, handle tubes as if they contain guanidine thiocyanate or similar chemicals.

SARS-CoV-2

Rejection criteria at SJCPHL:

Alert: DO NOT use VTM material that contains Guanidinium thiocyanate or any guanidine-containing materials on the Panther instrument. Highly reactive and/or toxic compound may form if combined with sodium hypochlorite (bleach).

- Dry swab submissions are unacceptable and will be rejected.
- Any swab submitted in media containing guanidinium isothiocyanate, guanidinium thiocyanate, guanidineisothiocyanate, guanidine thiocyanate, or like component is unacceptable and will be rejected.
- Any tubes that lack labelling that includes media contents, lot, and expiration date may contain guanidine.
- thiocyanate or a similar chemical; such vials are unacceptable and will be rejected.
- Calcium alginate swabs or swabs with wooden shafts are unacceptable as they may contain substances that inactivate some viruses and inhibit PCR testing.

UNACCEPTABLE specimens:



PrimeStore MTM



DNA/RNA Shield

Specimen rejection: Situations that could seriously compromise the validity of test results will result in specimen rejection. Some of the situations that can result in specimen rejection are:

- Unlabeled or mislabeled specimen.
- Specimen too old or in poor condition (i.e., hemolyzed, lipemic)
- Specimen submitted on grossly outdated media or transport kits.
- No specimen received with test requisition form.
- Anaerobic culture request from aerobic transport.
- Specimen leaked during transport.

Note: Irreplaceable or critical specimens that normally would be unsatisfactory for testing may be tested if the submitter accepts that results are equivocal and based on an unsatisfactory specimen. The unsatisfactory condition will be clearly stated as part of the final report.

San Joaquin County Specimen Collection Guide

References

California Dept. Health Microbial Disease Laboratory Test guide.

<https://www.cdph.ca.gov/Programs/PSB/Pages/MicrobialDiseasesLaboratory.aspx>

California Dept. Health Viral Rickettsial Disease Laboratory Test guide.

https://www.cdph.ca.gov/Programs/CID/DCDC/Pages/VRDL_Specimen_Submittal_Forms.aspx

Photos on front cover taken at San Joaquin County Public Health Laboratory from routine specimens:

Top Left: Bacterial vaginosis gram stain.

Top Right: Microscopic image (Lactophenol cotton blue mount) of the organism *Coccidioides immitis*, the causative agent of Valley fever.

Bottom Left: Microscopic image (Ziehl Nelson stain) of a “corded” mass of cells of the organism *Mycobacterium tuberculosis*, the causative agent of tuberculosis.

Bottom: Right: Microscopic image of the larvae stage of the parasite *Strongyloides stercoralis*.

Appendices

1. Laboratory Supply Request Form
2. Bacteriology CI Form
3. Mycology CI Form
4. AFB CI Form
5. SARS-COV2/Influenza Form
6. Mpox Form
7. List of SJCPHL Tests with TAT
8. Title 17

Refer to the below to access the lab forms/ Appendices on the PHS website.

http://www.sjcphs.org/disease/public_health_Laboratory.aspx